



SD32

FEATURES

- Direct bracket torque take out
- Industry standard mount pattern fits multiple caliper sizes for vehicle commonality
- Automotive pin seals to keep out dust & debris
- Forged aluminum caliper housing
- Double acting pad springs
- Bi-directional caliper allows for simplification of vehicle BOM, lower caliper PN inventory
- Multiple piston and friction material options



SPECIFICATIONS

Max caliper pressure	1813 psi
Piston Diameter	1.25 in
# pistons per side	2
MIN MU	0.35
MAX MU	0.55
MIN ROTOR DIA	8 in
MAX Rotor DIA	11.5 in
Caliper offset	0.935 in

Specifications are guidelines only and subject to change. Consult Hayes Performance Systems for specific model, part number, and assembly drawings -contact@hbpsi.com.

REFERENCE DIMENSIONS

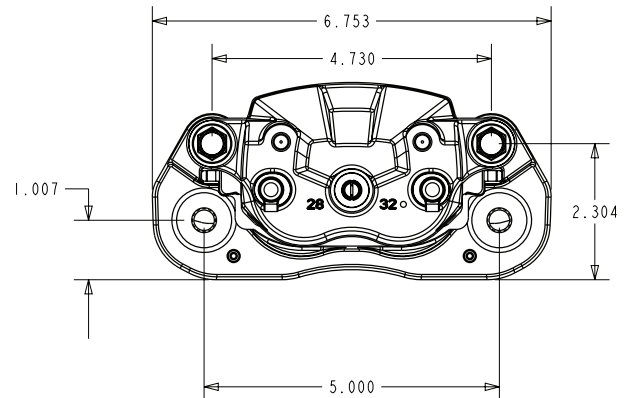

TORQUE INFORMATION

